



Heavy-duty
forklifts designed
for longevity

HUAYA

CARRY THE FUTURE
胜出，必有所长

6.0-7.0 TONS

Diesel /Gasoline/LPG Forklift
柴油/汽油/LPG叉车

·Stage V ·EPA 4

Forklifts are special safety equipment, and each component of the vehicle is a safety component. The safety valve in the oil cylinder will ensure the safe use of the vehicle.



Features



Fork positioner & Side shifter

A hydraulic attachment that moves the tines (forks) together or apart. This removes the need for the operator to manually adjust the tines for different-sized loads.



Combination display

LED Display offers useful information, such as the fuel meter, water temperature indicator and hour meters the convenience of operator.

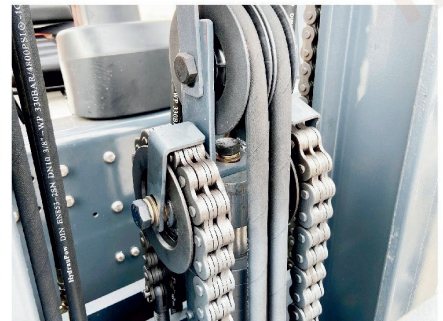

Wide view mast

Strong U-steel, lifting cylinder, chain, bearing, and is equipped with a safety valve, when the oil cylinder or oil pipe breaks, the mast will not fall down instantly, will slowly decline.

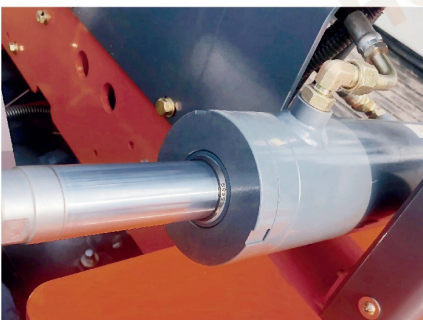

Reliable component

SHIMADZU pump and valve, EATON oil pipe ensure precise control and durable lifetime, never leak oil



Comfortable seat

The new suspension adjustable seats make long-term operation more comfortable and the safety of the driver is guaranteed with seat belts.

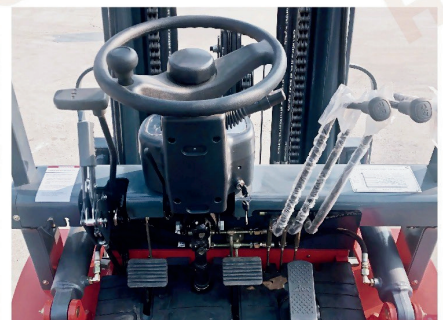

Ergonomics

Roomy foot space of 1.06 meters wide enables a comfort operation. Hydraulic controls are located besides display for maximum operator comfort, while allowing easy Left-side entry and exit.

The publicized pictures, specification and parameter is offered to refer, please see according to the real goods

注：本宣传图册图片，规格参数仅供参考，以实物为准。



**Heavy-duty
forklifts designed
for longevity.**

México Office

Av. Jorge Jiménez Cantú S/N, Plaza Antigua 1, edif. 4-B, piso 2, oficina 201, Col. Hacienda de Valle Escondido, Zona Esmeralda, Atizapán de Zaragoza, Edo. de Méx., C.P. 52937
Whatsapp 55 2094 9972

China Office

Room 423, Fuhua Plaza, 25 Fuhua East Road, Panyu District, Guangzhou City, Guangdong Province, China Zip Code 511403
Phone +8618529273426
info@cvg-forklifts.com



Heavy-duty
forklifts designed
for longevity

HUAYA CARRY THE FUTURE
胜出，必有所长

Machine 2D Graph

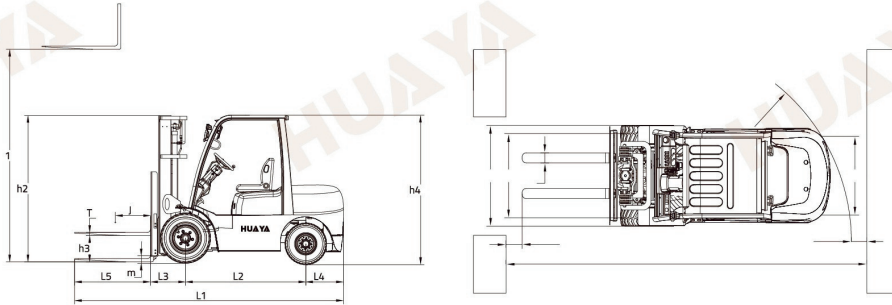

6.0-7.0 TONS

Diesel /Gasoline/LPG Forklift
柴油/汽油/LPG叉车

Machine Parameters

| 特征 Characteristics | | CPC60 | CPC70 | |
|--|------------|--------------|--------------|----------|
| Power 动力 | - | Diesel | Diesel | optional |
| Rated Capacity 额定荷载 | kg | 6000 | 7000 | / |
| Load Center 载荷中心 | J(mm) | 600 | 600 | / |
| Max. Lifting Height 提升高度 | H1(mm) | 3000 | 3000 | optional |
| Free Lifting Height 自由提升高度 | H3(mm) | 150 | 150 | optional |
| Fork Size L×W×H 货叉尺寸 | L5×W×H(mm) | 1220×150×60 | 1220×150×65 | optional |
| Mast Tilting Angle Forward/Backward 门架倾角 | ° | 6/12 | 6/12 | / |
| Min. Turning Radius 最小转弯半径 | R1(mm) | 3250 | 3380 | / |
| Min. Ground Clearance(mast) 最小离地间隙 | Ra(mm) | 200 | 200 | / |
| Overhead Guard Height 护顶架高度 | H4(mm) | 2460 | 2450 | optional |
| 性能 Performance | | | | |
| Max. Traveling Speed(loaded) 最大行驶速度 | km/h | 26 | 26/29 | / |
| Max. Lifting Speed(loaded/unloaded) 最大起升速度 | mm/s | 400 | 460/500 | / |
| Max. Traction/Gradeability(loaded) 最大牵引力/爬坡能力 | KN/° | 51.4 | 53 | / |
| Min. Right Angle Stacking Aisle Width 最小直角通道宽度 | mm | 2960 | 3040 | / |
| 尺寸 Dimensions | | | | |
| Overall Length(without fork) 全长 | L1(mm) | 3470 | 3580 | / |
| Overall Width 全宽 | W1(mm) | 1995 | 1995 | / |
| Mast Lowered Height 门架落地高度 | H2(mm) | 2625 | 2625 | optional |
| Mast Extended Height 货叉最大起升时高度(带挡货架) | mm | 4380 | 4420 | optional |
| 底盘 Chassis | | | | |
| Tyre(Front) 前轮胎 | - | 8.25-15-14PR | 8.25-15-14PR | optional |
| Tyre(Rear) 后轮胎 | - | 8.25-15-14PR | 8.25-15-14PR | optional |
| Wheelbase 轴距 | L2(mm) | 2250 | 2250 | / |
| Tires distance(Front/Rear) 轮距 | S(mm) | 1470/1700 | 1470/1700 | / |
| Vehicle weight(Non-load) 自重 | kg | 8640 | 9300 | / |
| 驱动 Powertrain | | | | |
| Battery(Voltage/Capacity) 蓄电池 | V/Ah | (12/80)×2 | (12/80)×2 | / |
| Engine(Brand) 发动机(品牌) | - | Quanchai | Quanchai | optional |
| Engine(Rated power) 发动机(额定功率) | kw/r.p.m | 85/2200 | 85/2200 | optional |
| Engine(Rated torque) 发动机(额定转矩) | Nm/r.p.m | 500/1600 | 500/1600 | optional |
| Engine(Cylinder amount) 发动机(气缸数量) | - | 4 | 4 | optional |
| Engine(Bore×Stroke) 发动机(缸径×冲程) | mm | 4-105X124 | 4-105X124 | optional |
| Engine(Displacement) 发动机(排量) | L | 4.3 | 4.3 | optional |
| Fuel Tank Capacity 燃油箱容量 | L | 160 | 160 | / |
| Transmission(Front/Rear) 传动档位(前/后) | - | 2/2 | 2/2 | optional |
| Working Pressure 工作压力 | Mpa | 20 | 20 | / |

Capacity Chart

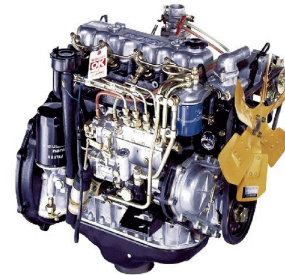
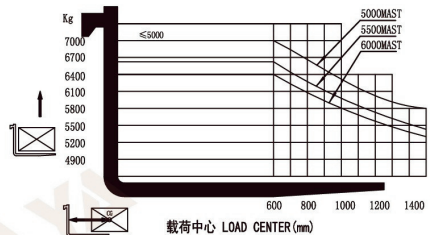
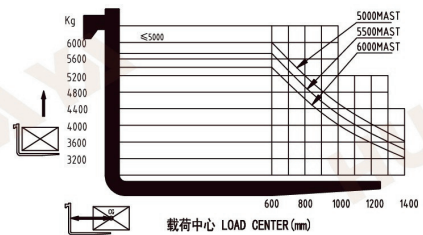

ISUZU C240

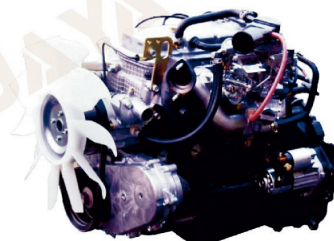

NISSAN K25

Remarks: The above parameters are based on 3M duplex standard mast.